

ISL9440BEVAL1Z Evaluation Board

The ISL9440BEVAL1Z evaluation board features the ISL9440B. The ISL9440B is quad-output controller that integrates three PWM synchronous buck controllers and one low-dropout linear regulator controller. Then ISL9440B offers programmable soft-start, independent enable functions and integrates OV/OC/OT protection. The current mode control architecture and internal compensation network keep peripheral components to a minimum. The strong gate drivers of the ISL9440B are capable of driving 20A current for PWM1 and PWM2 and 15A for PWM3.

Table 1 shows the difference in terms of ISL944xx family features.

TABLE 1. FEATURES OF ISL944X FAMILY

PART NUMBER	EARLY WARNING	SWITCHING FREQUENCY (kHz)	SOFT-STARTING TIME (ms)
ISL9440	YES	300	1.7
ISL9440A	YES	600	1.7
ISL9441	NO	300	1.7
ISL9440B	YES	300	PROGRAMMABLE
ISL9440C	YES	600	PROGRAMMABLE

The ISL9440BEVAL1Z is easy to set up to evaluate the performance of the ISL9440B. Please refer to the “Electrical Specifications” for typical performance summary.

Electrical Specifications

Recommended operation conditions, unless otherwise noted. Refer to schematic and typical performance curves.

PARAMETER	TEST CONDITIONS	MIN	TYP	MAX	UNITS
V _{IN}	All outputs are in regulation	15	19	23	V
V _{OUT1}		4.85	5.0	5.15	V
V _{OUT2}		3.25	3.32	3.4	V
V _{OUT3}		11.64	12.0	12.36	V
V _{OUT4}		2.47	2.50	2.58	V
PWM1 Rated Current	V _{IN} = 19V, T _A = +25°C, No forced airflow, All three PWM outputs are fully loaded		15	18	A
PWM2 Rated Current			15	18	A
PWM3 Rated Current			12	14	A
LDO Rated Current	R7 = 0Ω, R4 is not populated		0.8	1.0	A
V _{OUT1} Peak-to-Peak Ripple	V _{IN} = 23V, All three PWM outputs are fully loaded, Oscilloscope is with full bandwidth.		83		mV _{P-P}
V _{OUT2} Peak-to-Peak Ripple			61		mV _{P-P}
V _{OUT3} Peak-to-Peak Ripple			109		mV _{P-P}

What's Insides

The Evaluation Board Kit contains the following materials:

- The ISL9440BEVAL1Z
- The ISL9440B, ISL9440C datasheet
- This EVAL KIT document

Recommended Equipment

The following materials are recommended to perform testing:

- 0V to 24V power supply with at least 20A source current capability
- Three electronics loads capable of sinking current up to 20A
- Digital multimeters (DMMs)
- 100MHz quad-trace Oscilloscope
- Signal generator (for load transient tests)

Quick Set-up Guide

1. Ensure that the circuit is correctly connected to the supply and electronics loads prior to applying any power. Please refer to Figure 1 for proper set-up.
2. Connect Jumpers J3, J4 and J5 in the ENx positions.
3. Turn on the power supply
4. Adjust input voltage V_{IN} within the specified range and observe output voltage. The output voltage variation should be within 3%.
5. Adjust load current within the specified range and observe output voltage. The output voltage variation should be within 3%.
6. Use oscilloscope to observe output voltage ripple and Phase node ringing. For accurate measurement, refer to Figure 2 for proper test set-up.

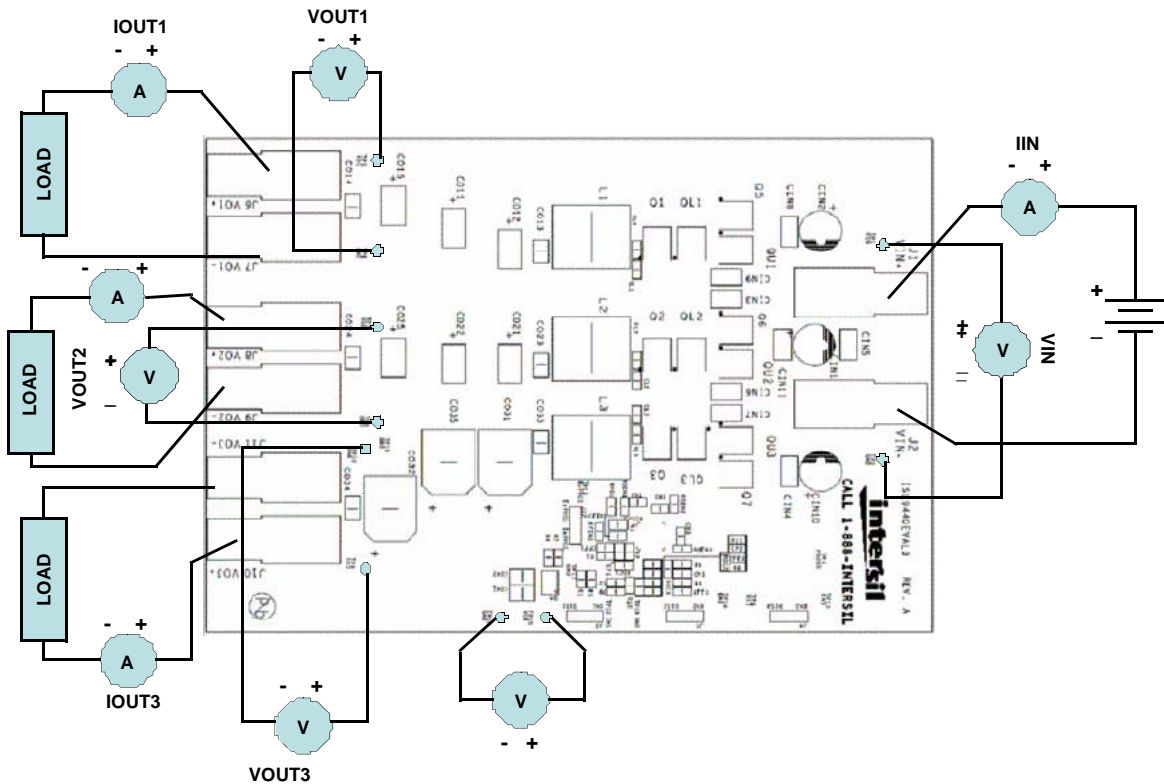

FIGURE 1. PROPER TEST SET-UP

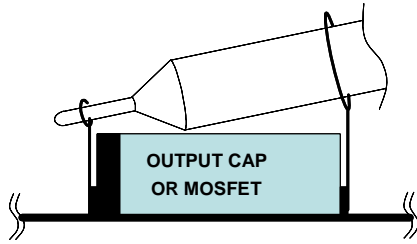

FIGURE 2. PROPER PROBE SET-UP TO MEASURE OUTPUT RIPPLE AND PHASE NODE RINGING.

Load Transient Circuit Set-up

1. Select a DPAK N channel MOSFET with V_{DSS} breakdown > 20V.
2. Install the load transient circuit as indicated on the schematic. Refer to Figure 3 for details.
3. R12, R14, R16 are 10k Ω resistors for discharging the MOSFET gates.
4. R13, R15 and R17 are current sensing resistors to monitor the load step. For accurate measurement, please use 5% tolerance sensing resistor or better. To alleviate thermal stress, use 0.1 Ω or smaller resistance. The resistance of the sensing resistors sets the current scale on the oscilloscope.

Typical Evaluation Board Performance Curves

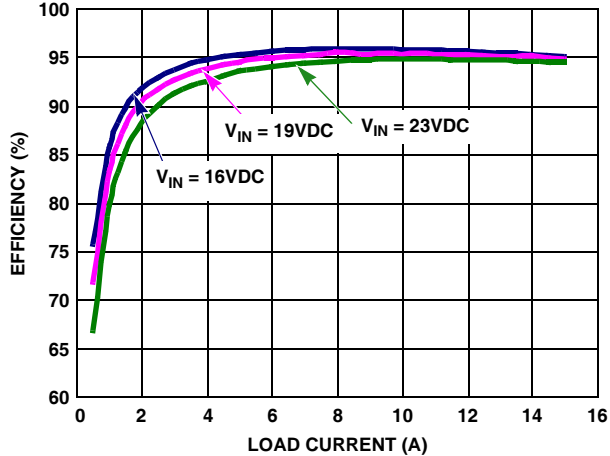

FIGURE 4. PWM1 EFFICIENCY vs LOAD ($V_O = 5.0V$)

5. Apply pulse square waveform to the ISTEP_CLK1, ISTEP_CLK2 and ISTEP_CLK3. The duty cycle of the pulse waveform should be small (<5%) to limit thermal stress on current sensing resistor and the MOSFETs (Q8, Q9 and Q10)
6. The amplitude of the clock sets the current step amplitude. Adjust the clock amplitude and slew rate to set the current step and slew rate.
7. Monitor overshoot and undershoot at corresponding output.

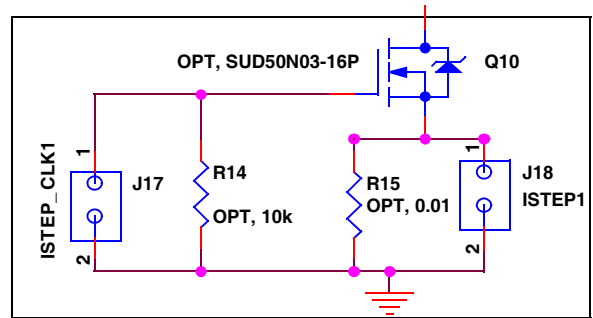

FIGURE 3. LOAD TRANSIENT CIRCUIT FOR PWM1

$V_{IN} = 9V$, unless otherwise specified.

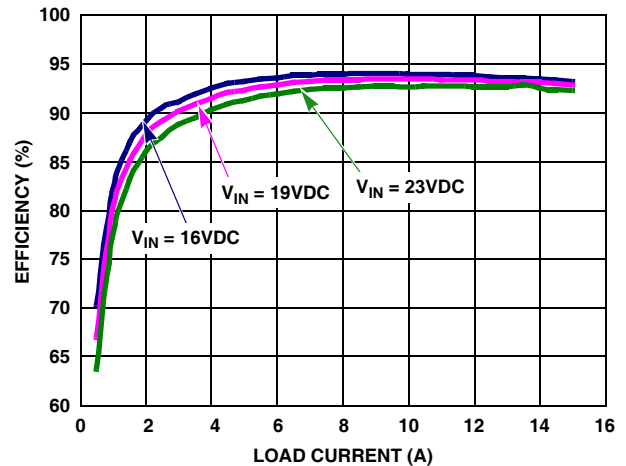

FIGURE 5. PWM2 EFFICIENCY vs LOAD ($V_O = 3.3V$)

Typical Evaluation Board Performance Curves

$V_{IN} = 9V$, unless otherwise specified. (Continued)

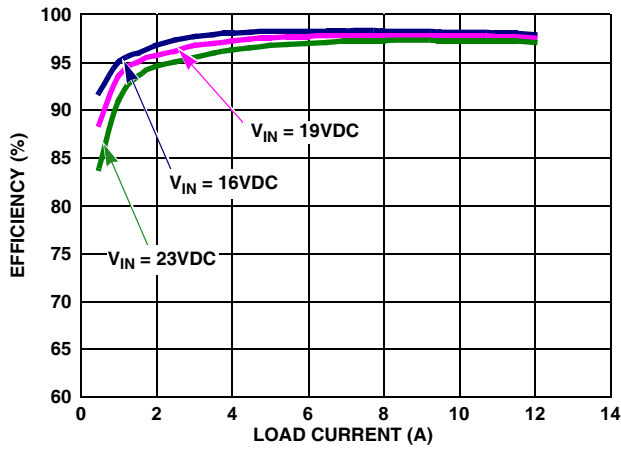

FIGURE 6. PWM3 EFFICIENCY vs LOAD ($V_O = 12V$)

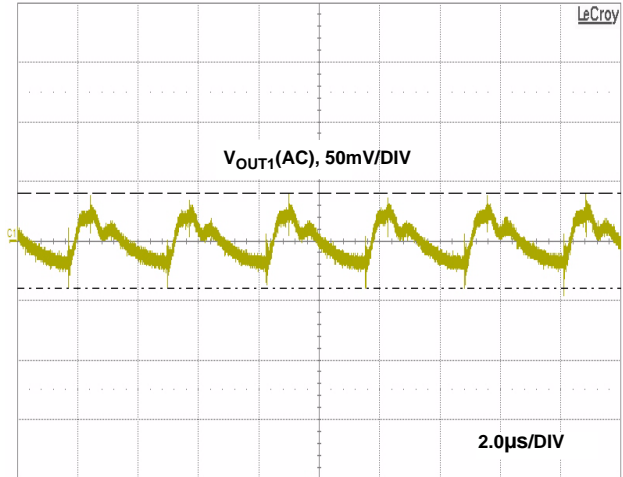

FIGURE 7. PWM1 OUTPUT RIPPLE UNDER MAX LOAD ($V_{IN} = 23V$, $I_{O1} = I_{O2} = 15A$, $I_{O3} = 12A$, FULL BANDWIDTH)

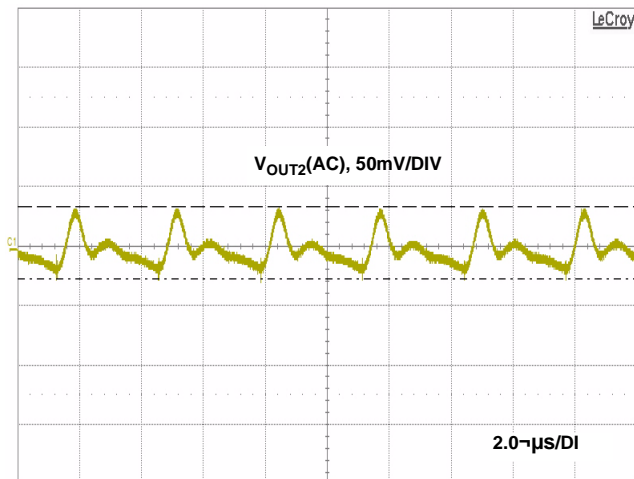

FIGURE 8. PWM2 OUTPUT RIPPLE UNDER MAX LOAD ($V_{IN} = 23V$, $I_{O1} = I_{O2} = 15A$, $I_{O3} = 12A$, FULL BANDWIDTH)

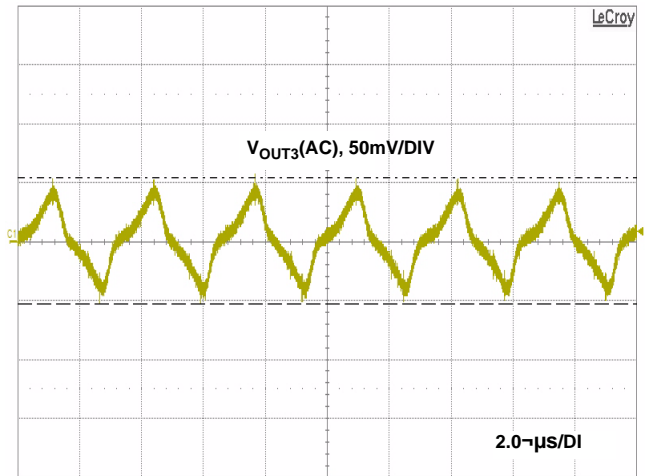

FIGURE 9. PWM3 OUTPUT RIPPLE UNDER MAX LOAD ($V_{IN} = 23V$, $I_{O1} = I_{O2} = 15A$, $I_{O3} = 12A$, FULL BANDWIDTH)

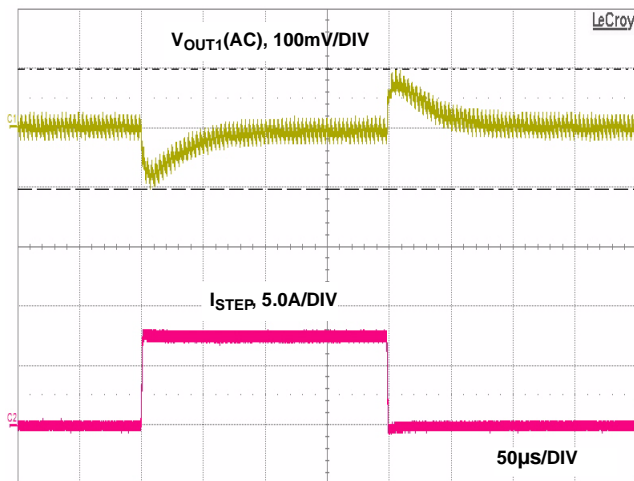

FIGURE 10. PWM1 LOAD TRANSIENT RESPONSE (LOAD STEP FROM 3.75A TO 11.25A)

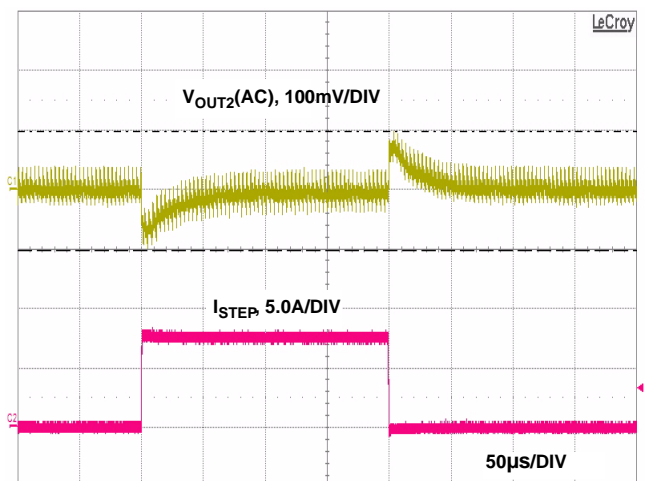

FIGURE 11. PWM2 LOAD TRANSIENT RESPONSE (LOAD STEP FROM 3.75A TO 11.25A)

Typical Evaluation Board Performance Curves $V_{IN} = 9V$, unless otherwise specified. (Continued)

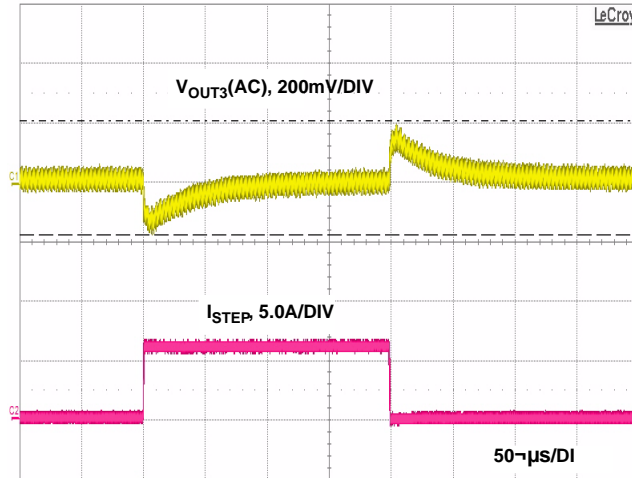
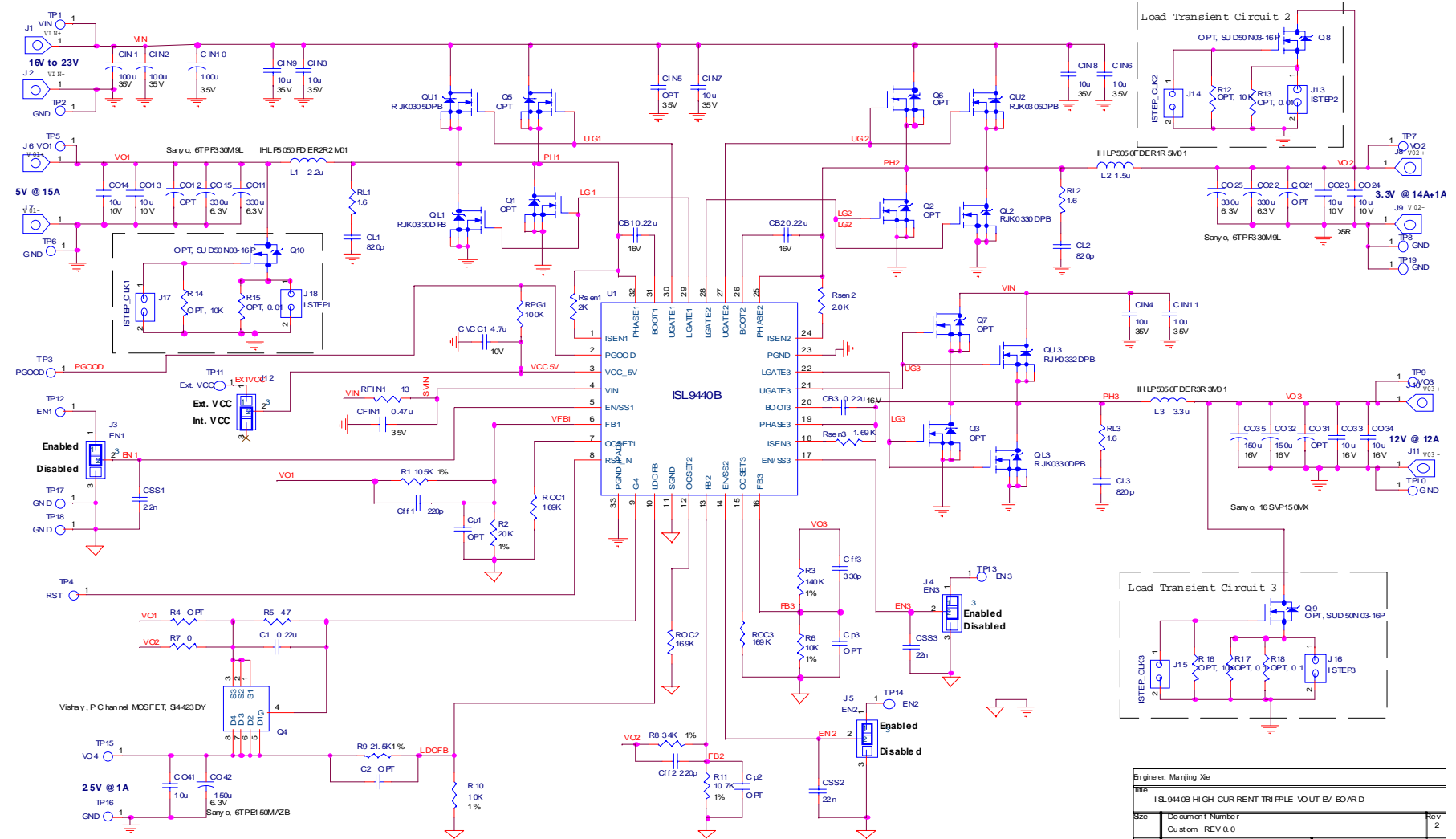

FIGURE 12. PWM3 LOAD TRANSIENT RESPONSE (LOAD STEP FROM 3A TO 9A)

Schematic



Engineer: Ma Junjie	
Title: ISL9440B HIGH CURRENT TRIPLE VOUT EV BOARD	
Size: Custom	Document Number: REV 0.0
Date: Monday, January 26, 2009	Printed: 1 of 1

Application Note 1454

TABLE 2. BILL OF MATERIALS

ITEM	QTY	PART REFERENCE	VALUE	DESCRIPTION	PART NUMBER	MANUFACTURER
1	1	C1	0.22μF			
2	3	CB1, CB2, CB3	0.22μF	CERAMIC CAPS, X5R, 16V		AVX, TDK, Murata
3	1	CFIN1	0.47μF	CERAMIC CAPS, X5R, 35V		AVX, TDK, Murata
4	3	CIN1, CIN2, CIN11	150μF	ALUM. ELEC. CAPS, 35V		Panasonic
5	6	CIN3, CIN4, CIN6, CIN7, CIN8, CIN9	10μF	CERAMIC CAPS, X5R, 35V		AVX, TDK, Murata
6	2	CO11, CO12, CO21, CO22	330μF	POSCAP, 6.3V, ESR 9m	6TPF330M9L	Sanyo
7	5	CO13, CO14, CO23, CO24, CO41	10μF	CERAMIC CAPS, 0805, X5R, 6.3V		AVX, TDK, Murata
8	2	CO31, CO32	150μF	SANYO, OSCON, 16V		Sanyo
9	2	CO33, CO34	10μF	CERAMIC CAPS, X5R, 25V		AVX, TDK, Murata
10	1	CO42	150μF	POSCAP, 6.3V	4TPE100MZB	Sanyo
11	1	CVCC1	4.7μF	CERAMIC CAPS, X5R, 16V		AVX, TDK, Murata
12	2	CFF1, CFF2	220pF	CERAMIC CAPS, NP0, 50V		Generic
13	1	CFF3	330pF	CERAMIC CAPS, NP0, 50V		Generic
14	3	CSS1, CSS2, CSS3	22nF	CERAMIC CAPS, NP0, 50V		Generic
15	1	L1	2.2μH	POWER INDUCTOR	IHLP5050FDER2R2M01	Vishay
16	1	L2	1.5μH	POWER INDUCTOR	IHLP5050FDER1R5M01	Vishay
17	1	L3	3.3μH	POWER INDUCTOR	IHLP5050FDER3R3M01	Vishay
18	3	QL1, QL2, QL3		N MOSFET, 30V	RJK0330DPB	Renesas
19	2	QU1, QU2		N MOSFET, 30V	RJK0305DPB	Renesas
20	1	QU3		N MOSFET, 30V	RJK0332DPB	Renesas
21	1	Q4		P MOSFET, 20V	Si4423DY	Vishay
22	1	R1	105kΩ	RESISTOR, 0603, 1/16W		Generic
23	1	R2	20kΩ	RESISTOR, 0603, 1/16W		Generic
24	2	R6, R10	10kΩ	RESISTOR, 0603, 1/16W		Generic
25	1	R3	140kΩ	RESISTOR, 0603, 1/16W		Generic
26	1	R5	47Ω	RESISTOR, 0603, 1/16W		Generic
27	1	R8	34kΩ	RESISTOR, 0603, 1/16W		Generic
28	1	R9	21.5kΩ	RESISTOR, 0603, 1/16W		Generic
29	1	R11	10.7kΩ	RESISTOR, 0603, 1/16W		Generic
30	1	RFIN1	4.7Ω	RESISTOR, 0603, 1/16W		Generic
31	3	ROC1, ROC2, ROC3	169kΩ	RESISTOR, 0603, 1/16W		Generic
32	1	RPG1	100kΩ	RESISTOR, 0603, 1/16W		Generic
33	2	RSEN1, RSEN2	2.0kΩ	RESISTOR, 0603, 1/16W		Generic
34	1	RSEN3	1.69kΩ	RESISTOR, 0603, 1/16W		Generic
35	1	U1		QUAD OUTPUT CONTROLLER	ISL9440B	Intersil
OPTIONAL COMPONENTS OR RESISTOR JUMPERS						
1	1	C2	OPT			Generic
2	3	CL1, CL2, CL3	820pF	CERAMIC CAPS, 0805		Generic
3	0	CIN11, CIN5	OPT			Generic
4	0	CO15, CO25, CO35	OPT			Generic

Application Note 1454

TABLE 2. BILL OF MATERIALS (Continued)

ITEM	QTY	PART REFERENCE	VALUE	DESCRIPTION	PART NUMBER	MANUFACTURER
5	0	CP1, CP2, CP3	OPT			Generic
6	0	Q1, Q2, Q3, Q5, Q6, Q7	OPT	N MOSFET, 30V		
7	3	RL1, RL2, RL3	1.6 Ω	RESISTOR, 0805, 1/8W		Generic
8	0	R4	OPT			Generic
9	1	R7	0	Resistor jumper		Generic
EVALUATION BOARD HARDWARE						
1	8	J1, J2, J6, J7, J8, J9, J10, J11		Big Lug		
2	1	J3, J4, J5, J12		3 HEAD JUMPER		
3	15	TP1 ~ TP15		TEST POINT		
4	4			STAND OFF		

Intersil Corporation reserves the right to make changes in circuit design, software and/or specifications at any time without notice. Accordingly, the reader is cautioned to verify that the Application Note or Technical Brief is current before proceeding.

For information regarding Intersil Corporation and its products, see www.intersil.com

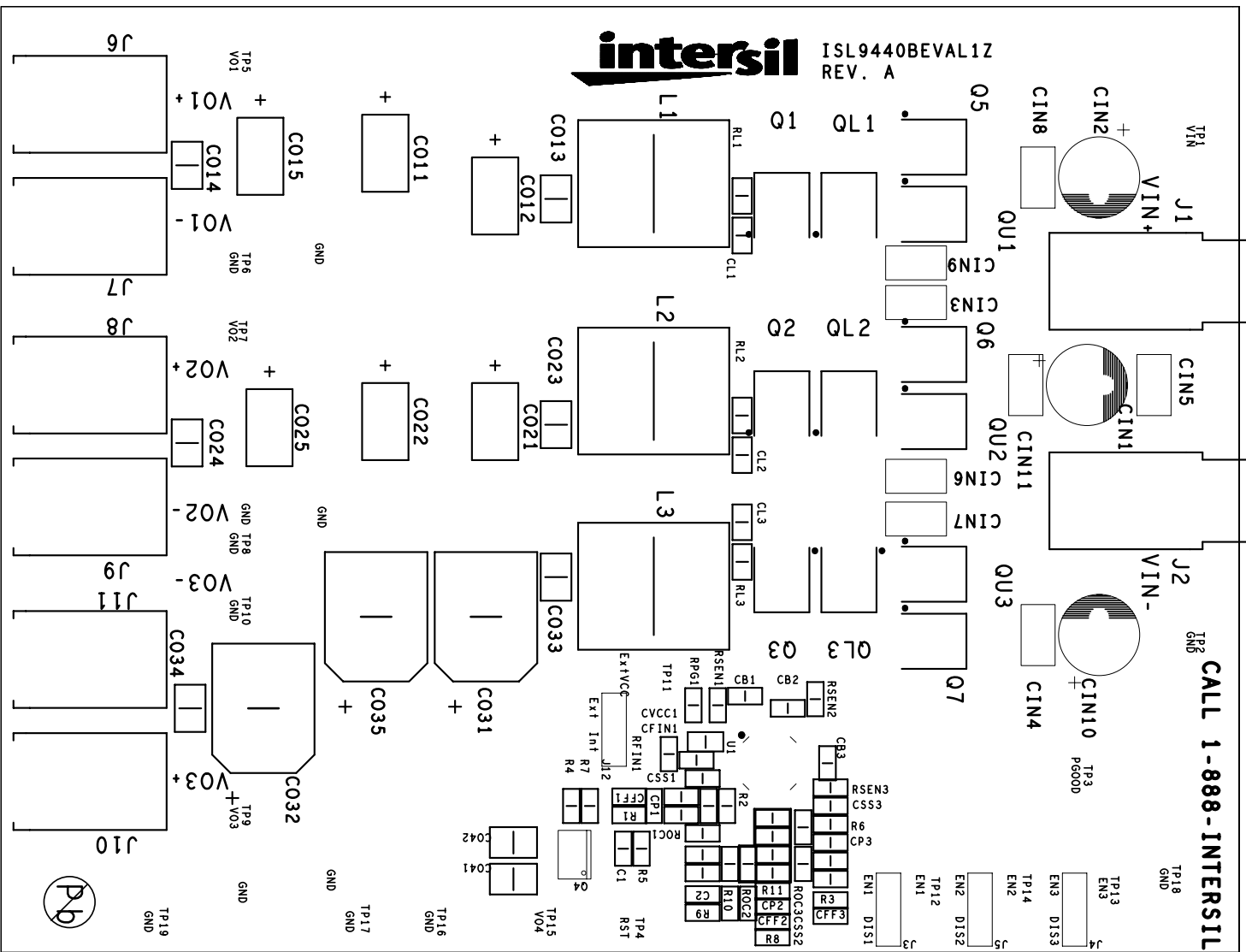

FIGURE 13. TOP COMPONENTS

ISL9440BEVAL1Z PCB Layout

intersil ISL9440BEVAL1Z
REV. A

CALL 1-888-INTERMIL

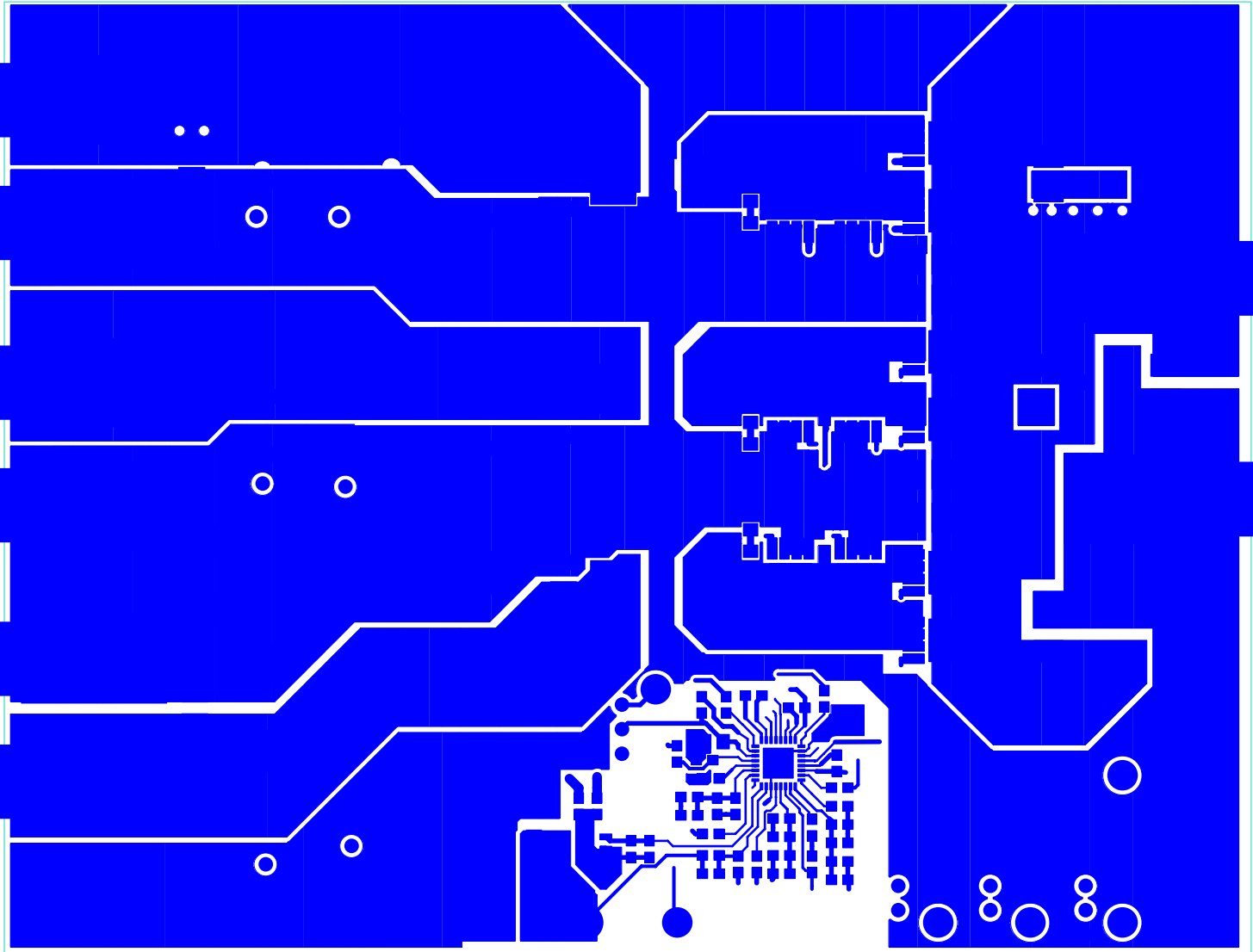

FIGURE 14. TOP LAYER ETCH

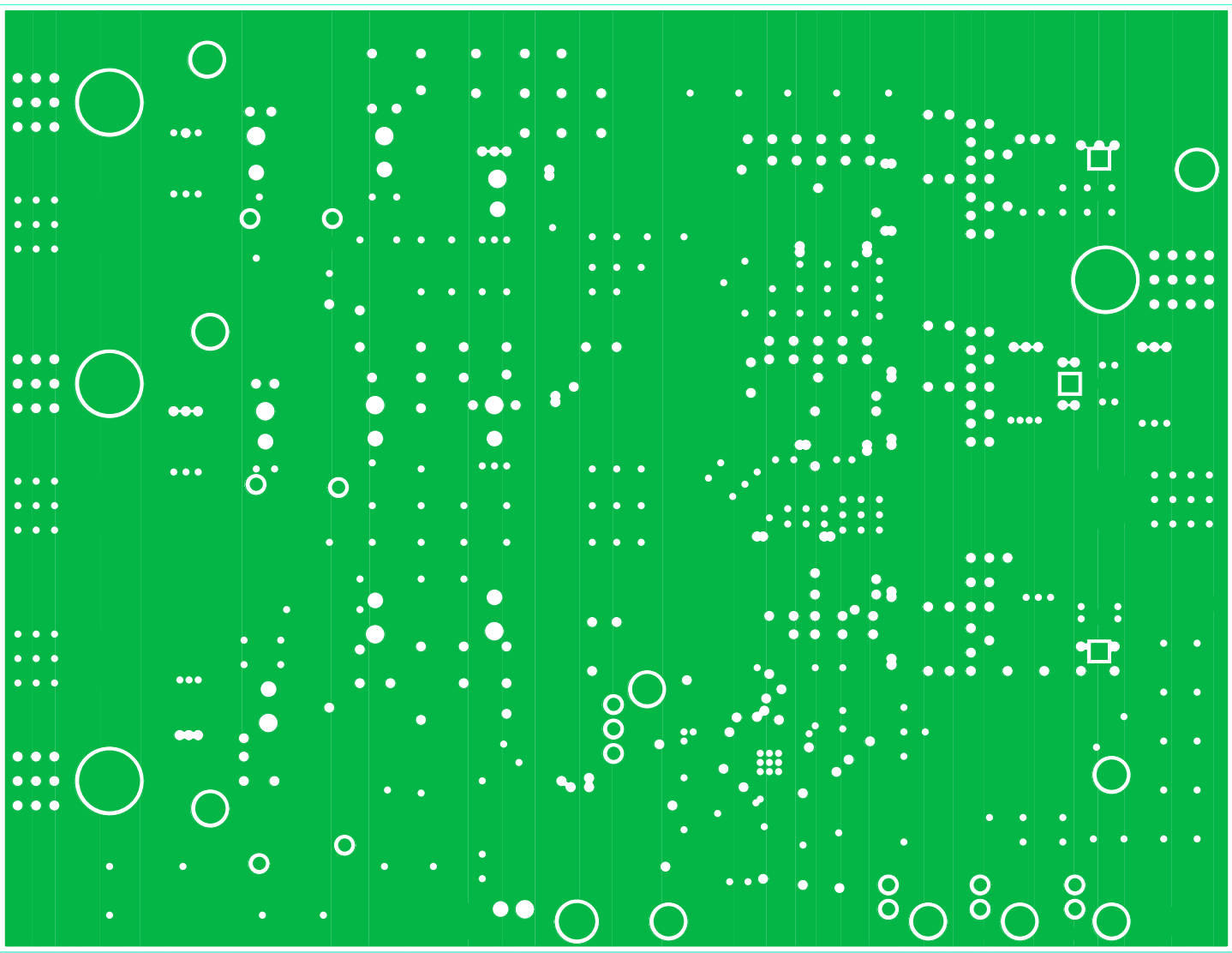

FIGURE 15. SECOND LAYER ETCH

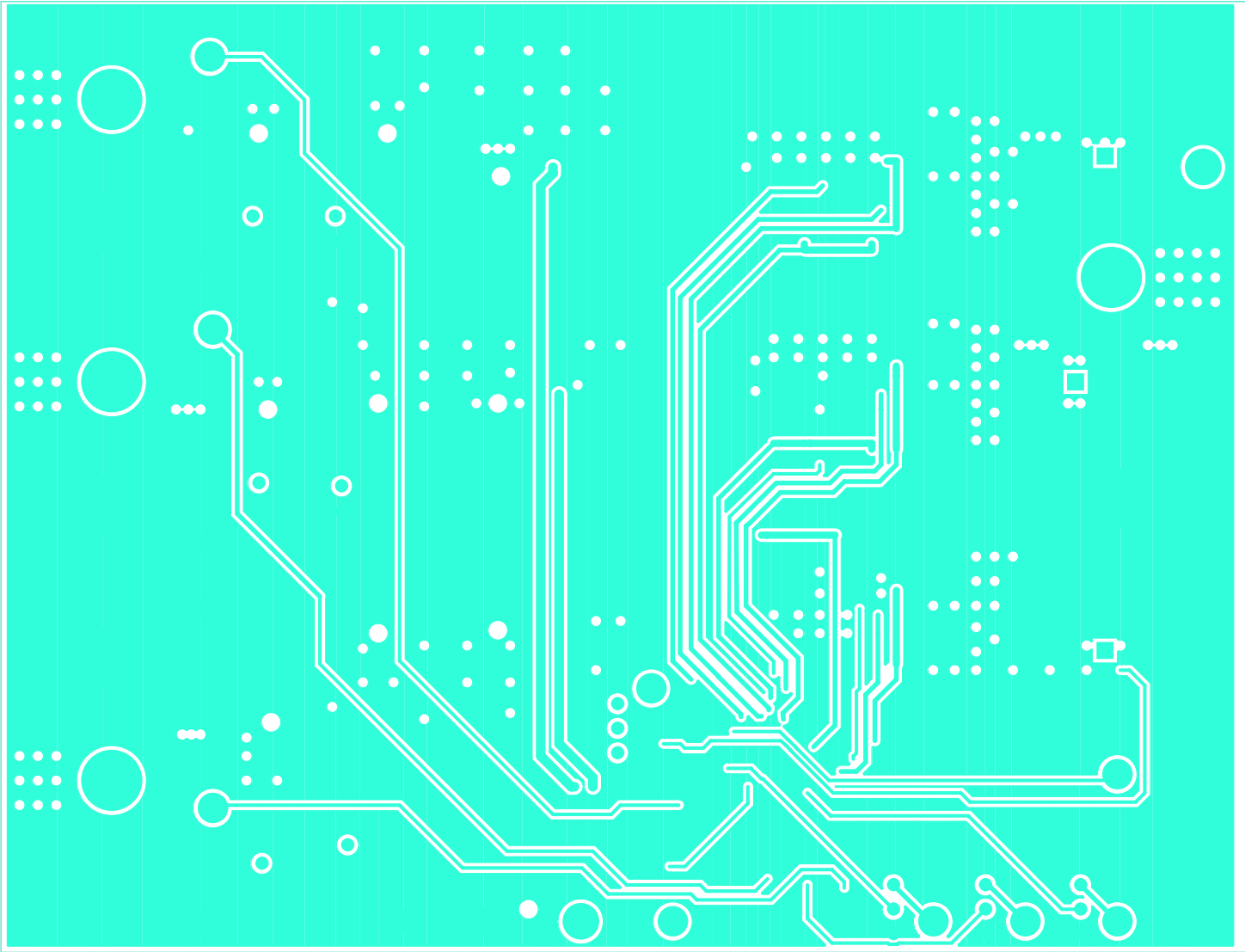

FIGURE 16. THIRD LAYER ETCH

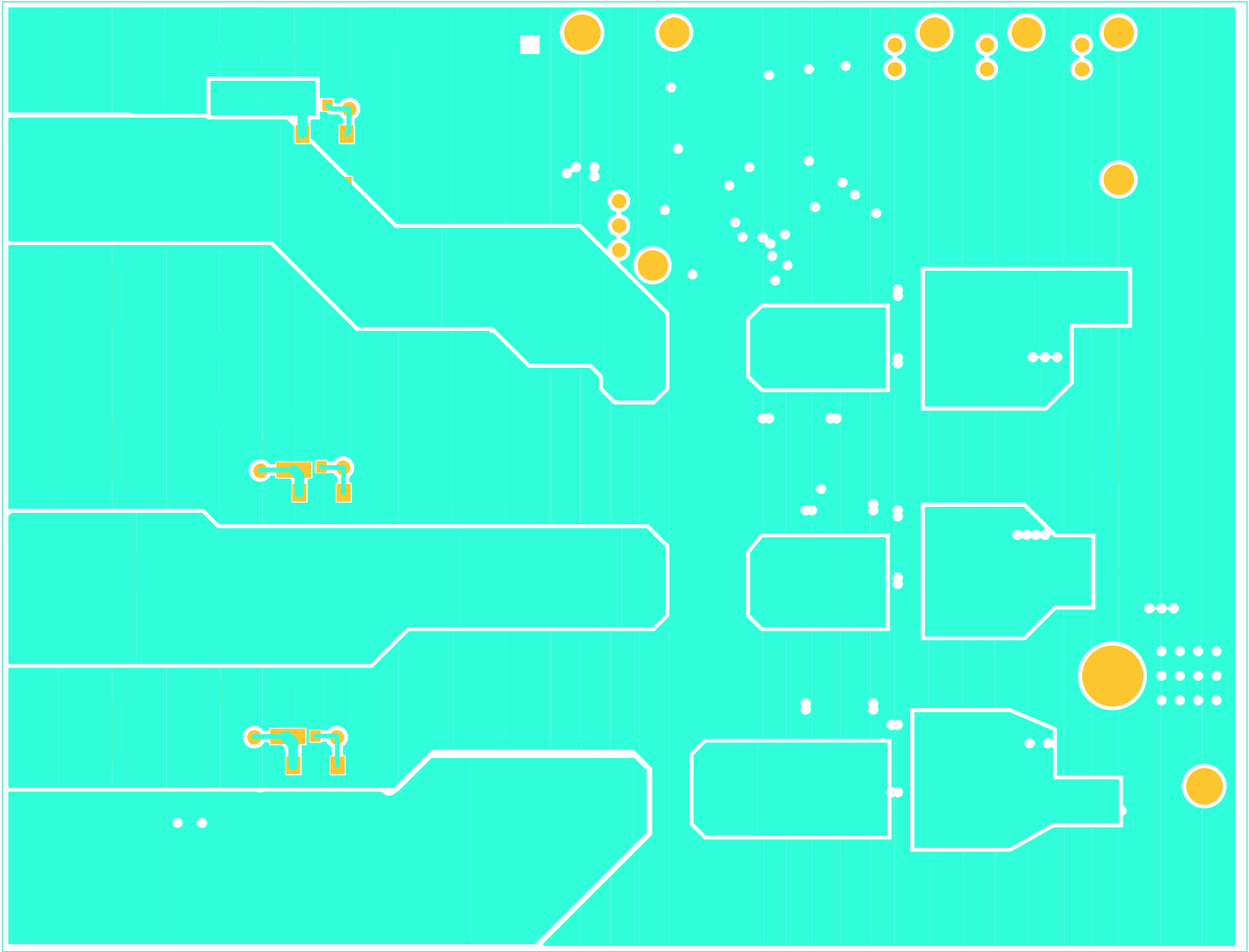

FIGURE 17. BOTTOM LAYER ETCH (MIRRORED)

